

# DC/AC CLAMP METER

Model CM-01

## USERS MANUAL

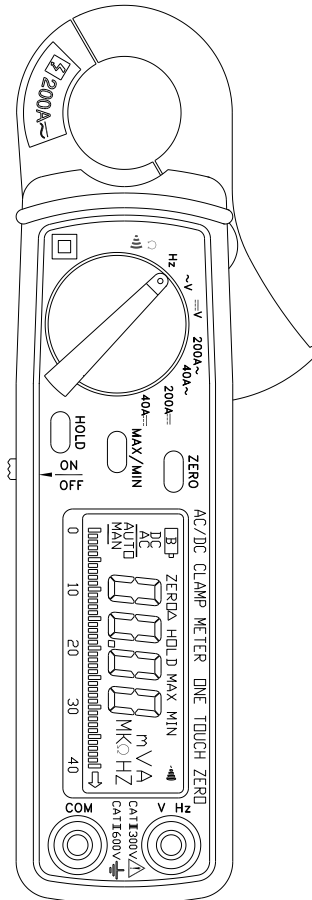











**PROVA INSTRUMENTS INC.**



**EN 61010-2-032**  
**CAT II 600V**  
**CAT III 300V**  
**Pollution Degree 2**

**SYMBOLS showed on the clamp meter or in this manual:**

	Caution, risk of danger. Refer to accompanying documents
	Caution, risk of electric shock.
	Double Insulation
	Application around and removal from HAZARDOUS LIVE conductors is permitted.
	Earth (ground)
	AC (Alternating Current)
	DC (Direct Current)
	Both direct and alternating current
	Conforms to relevant European Union directives.
	Do not dispose of this clamp meter as unsorted municipal waste. Contact a qualified recycler for disposal.

### **Overvoltage Category I (CAT I):**

Equipment for connection to circuits in which measures are taken to limit the transient overvoltages to an appropriate low level.

### **Overvoltage Category II (CAT II):**

Energy-consuming equipment to be supplied from the fixed installation.

### **Overvoltage Category III (CAT III):**

Equipment in fixed installations.

## **SAFETY INFORMATION: (Read First Before Operation)**

Please follow the following instructions carefully for safe operation.

- NEVER use the clamp meter for Voltages higher than 600V.
- DO NOT hold the clamp meter beyond its tactile barrier.
- DO NOT use the clamp meter and accessories if they look damaged.
- USE CAUTION when working with high voltages.
- USE CAUTION when measuring the voltages higher than 30VAC rms or 60VDC. These voltages pose a shock hazard.
- USE EXTREME CAUTION when working around bare conductors or bus bars.
- ALWAYS use the clamp meter as the instructions in the manual.

<p><b>WARNING:</b> If the clamp meter is used in a manner Not specified by the manufacturer, the protection Provided by the clamp meter may be impaired.</p>
--

# TABLE OF CONTENTS

<b>1.Features</b> .....	2
<b>2. Panel Description</b> .....	3
<b>3.Operation Instructions</b> .....	4
3.1. DC/AC Current Measurements .....	5
3.2. DC/AC Voltage Measurements .....	5
3.3. Resistance and Continuity Measurement .....	7
3.4. Frequency (Hz) Measurement .....	7
3.5. Relative Reading Measurements .....	7
3.6. Holding the LCD Reading .....	7
3.7. Finding the MAX/MIN Value .....	7
<b>4.Specifications</b> .....	7
<b>5.Battery Replacement</b> .....	9
<b>6. Maintenance &amp; Cleaning</b> .....	10

## 1. Features

- 1.Accurate DC/AC digital clamp meter for current measurement.
- 2.10mA high resolution on 40A DC/AC range.
- 3.One touch zero for DCA adjustment.
- 4.23 mm diameter jaw.
- 5.Large 3 3/4 digits LCD
- 6.Fast bargraph display (20 times/sec.) for transient observation.
- 7.Continuity and frequency measurements.
- 8.Max/Min and Data Hold functions.
- 9.600V overload protection for ohm measurement.
- 10.Easy single rotary switch for any function selection.
- 11.Ideal for works in crowded switch box or cable areas.

## 2. Panel Description

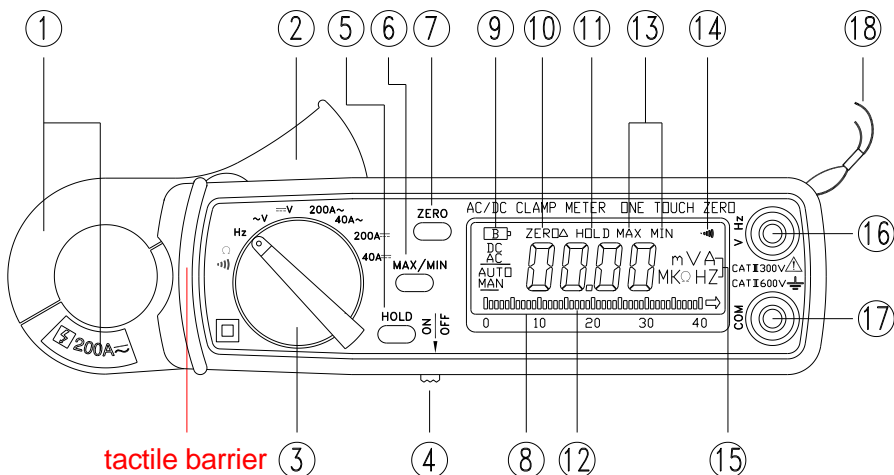

tactile barrier

#### 1. Transformer Jaw

This is used to pick up current signal. To measure DC/AC current, conductor must be enclosed by the jaw.

#### 2. Transformer Trigger

This is used to open the jaw.

#### 3. Function Selector Switch

This is used to select the function user desired, such as DCA, ACA, DCV, ACV, Hz, Ohm and Continuity.

#### 4. On/Off Switch

This is used to turn the power on or off.

#### 5. Data Hold Button

Once this button is pushed, reading shall be held on the LCD. Press again to release it.

#### 6. Max/Min Hold Button

This button is used to enable the maximum or minimum value to be displayed and updated during measurement. Press once, minimum value shall be displayed and updated. Press again, maximum value shall be displayed and updated. Press again (the third push), clamp meter return to normal measurement mode. Zero function will be disabled if MAX/MIN is enabled.

#### 7. Zero/Relative Button

Once this button is pressed, the current reading shall be set to zero and be used as

a zero reference value for all other subsequent measurement. The function is also used to remove offset value caused by the residual magnetism remained in the core for the DC current measurement. The Zero/Relative function will be disabled if the MAX/MIN button is pressed.

#### 8.LCD

This is a 3 3/4 digit Liquid Crystal Display with maximum indication of 3999. Function symbols, units, bargraph, sign, decimal points, low battery symbols, max/min symbols, and zero symbol are included.

#### 9.Low Battery Symbol

When this symbol appears, it means the battery voltage drops below the minimum required voltage. Refer to Section V for battery replacement.

#### 10.Zero/Relative Symbol

When this symbol appears, it means a reference value has been subtracted from the actual reading. The reading shown is a offseted value. Press and hold the zero button for 2 seconds to disable this function.

#### 11.Data Hold Symbol

Once the hold button is pressed, this symbol appears on LCD.

#### 12.Bargraph

Bargraph has forty segments. It displays segments proportional to the actual reading. Each segment represent one count.

#### 13.Max/Min Hold Symbol

Once the max/min button is pressed, either MAX or MIN shall be displayed on LCD

#### 14.Continuity Symbol

If ohm and continuity function is selected, this symbol shall appears on LCD.

#### 15.Units Symbols

Once a function is selected, corresponding unit (V,  $\Omega$ , A, or Hz) shall be displayed on LCD.

#### 16.V $\Omega$ Hz Input Terminal

This terminal is used as input for voltage, ohm/continuity, or frequency measurements.

#### 17.COM Terminal

This terminal is used as common reference input.

#### 18.Hand Strap

Put your hand through the hole of hand strap to avoid accidental drop of the clamp meter.

### **3.Operation Instructions**

### 3.1. DC/AC Current Measurements

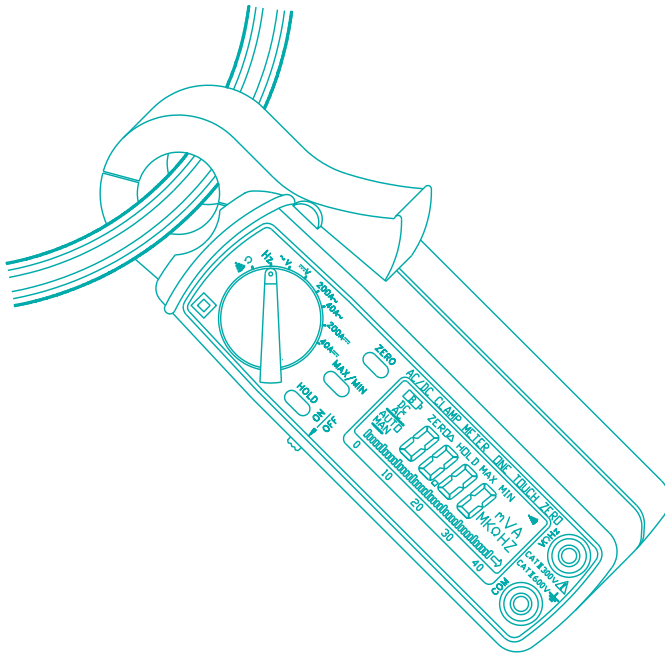

**WARNING:** Make sure that all the test leads are disconnected from the meter's terminals for current measurement.

#### 3.1.1. DC Current

- Set the rotary switch at 40A DC or 200A DC.
- Push the zero button to adjust the reading to zero.
- Press the trigger to open the jaw and fully enclose the conductor to be measured. No air gap is allowed between the two half jaws.
- Read the measured value from the LCD display.

#### 3.1.2. AC Current

- Set the rotary switch at 40A AC or 200A AC
- Press the trigger to open the jaw and fully enclose the conductor to be measured. No air gap is allowed between the two half jaws.
- Read the measured value from the LCD display.

### 3.2. DC/AC Voltage Measurements

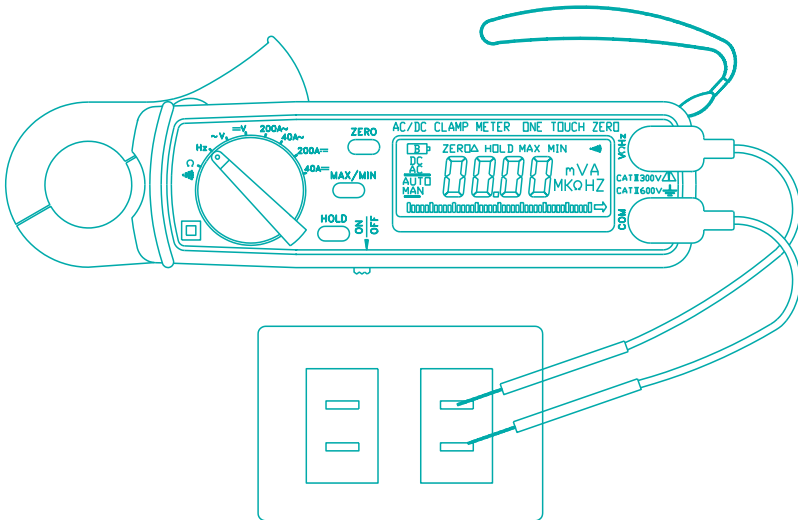

**WARNING:** Maximum input for DC V is 600, and for AC V is 600. Do not attempt to take any voltage measurement that exceeds the limits. Exceeding the limits could cause electrical shock and damage to the clamp meter.

### 3.2.1. DC Voltage

- Set the rotary switch at V DC.
- Insert the test leads into the input jack.
- Connect the test prods of the test leads in PARALLEL to the circuit to be measured.
- Read the measured value from the LCD display.

### 3.2.2. AC Voltage

- Set the rotary switch at V AC
- Insert the test leads into the input jack.
- Connect the test prods of the test leads in PARALLEL to the circuit to be measured.
- Read the measured value from the LCD display.

**WARNING:** Before taking any in-circuit resistance measurement, remove power from the circuit being tested and discharge all the capacitors.



### 3.3. Resistance and Continuity Measurement

3.3.1. Set the rotary switch at  $\Omega$

3.3.2. Insert the test leads into the input jack.

3.3.3. Connect the test prods of the test leads to the two ends of the resistor or circuit to be measured.

3.3.4. Read the measured value from the LCD display.

3.3.5. If the resistance is lower than  $40 \Omega$ , a beeping sound shall be heard.

### 3.4. Frequency (Hz) Measurement

3.4.1. Set the rotary switch at Hz.

3.4.2. Insert the test leads into the input jack.

3.4.3. Connect the test prods of the test leads in PARALLEL to the signal or circuit to be measured.

3.4.4. Read the measured value from the LCD display.

### 3.5. Relative Reading Measurements

The zero button also can be used to make a relative measurement. Once the button is pushed, the current reading is set to zero and a zero symbol shall be displayed on LCD. All the subsequent measurement shall be displayed as a relative value with respect to the value being zeroed. Press the zero button for 2 seconds to return to normal mode. But this function is disabled if MAX/MIN function is enabled. Please watch for symbol displayed on LCD.

### 3.6. Holding the LCD Reading

Press the HOLD button, then the reading shall be hold and kept on LCD.

### 3.7. Finding the MAX/MIN Value

Press the MAX/MIN button to enable the maximum and minimum values to be recorded and updated during measurement. Push the button once, the maximum value shall be displayed and updated. Push again (second push), the minimum value shall be displayed. Push again (third push), MAX/MIN function shall be disabled and return to the normal measurement mode. If MAX/MIN button is pressed, the ZERO function will be disabled and the ZERO symbol will disappear from LCD.

## **4. Specifications (23°C±5°C)**

**DC Current:**

Range	Resolution	Accuracy	Overload Protection
40A	10mA	$\pm 1.0\% \pm 2 \text{dgts}$	DC 400A
0-150A	100mA	$\pm 1.0\% \pm 2 \text{dgts}$	DC 400A
150-200A	100mA	$\pm 2.2\% \pm 2 \text{dgts}$	DC 400A

**AC Current:**

Range	Resolution	Accuracy		Overload Protection
		50/60 Hz	40 – 1KHz	
40A	10mA	$\pm 1.0\% \pm 3 \text{dgts}$	$\pm 1.5\% \pm 4 \text{dgts}$	AC 400A
0-150A	100mA	$\pm 1.0\% \pm 3 \text{dgts}$	$\pm 1.5\% \pm 4 \text{dgts}$	AC 400A
150-200A	100mA	$\pm 2.2\% \pm 3 \text{dgts}$	$\pm 2.5\% \pm 4 \text{dgts}$	AC 400A

**DC Voltage:**(Input Impedance:  $10M\Omega$ )

Range	Resolution	Accuracy	Overload Protection
400V	0.1V	$\pm 1.0\% \pm 2 \text{dgts}$	DC 1000V

**AC Voltage:**(Input Impedance:  $10M\Omega$ )

Range	Resolution	Accuracy		Overload Protection
		50/60 Hz	40 – 1KHz	
400V	0.1V	$\pm 1.5\% \pm 2 \text{dgts}$	$\pm 2.0\% \pm 4 \text{dgts}$	AC 800V

**Resistance ( $\Omega$ ) and Continuity:**(open voltage 0.4V)

Range	Resolution	Accuracy	Beeping	Overload Protection
40-400 $\Omega$	0.1 $\Omega$	$\pm 1.0\% \pm 2 \text{dgts}$	< 40.0 $\Omega$ (approx.)	AC 600V

**Frequency** (auto range):

Range (Hz)	Resolution (Hz)	Accuracy	Sensitivity	Overload Protection
100-100K	0.01 - 100	$\pm 0.5\% \pm 2 \text{dgts}$	10V	AC 600V

Indoor Use

Conductor Size: 23mm max. (approx.)

Battery Type:	two 1.5V SUM-3
Display:	3 3/4 LCD with 40 seg. bargraph
Range Selection:	manual
Overload Indication:	left most digit blinks
Power Consumption:	10 mA (approx.)
Low battery Indication:	
Sampling Time:	2 times/sec. (display) 20 times/sec. (bargraph)
Operating Temperature:	-10°C to 50°C
Operating Humidity:	less than 85% relative
Altitude :	up to 2000M
Storage Temperature:	-20°C to 60°C
Storage Humidity:	less than 75% relative
Dimension:	183mm (L) x 63.6mm (W) x 35.6mm (H) 7.2" (L) x 2.5" (W) x 1.4" (H)
Weight:	190g (battery included)
Accessories:	Carrying bag x 1 Users manual x 1 1.5V battery x 2

## 5. Battery Replacement

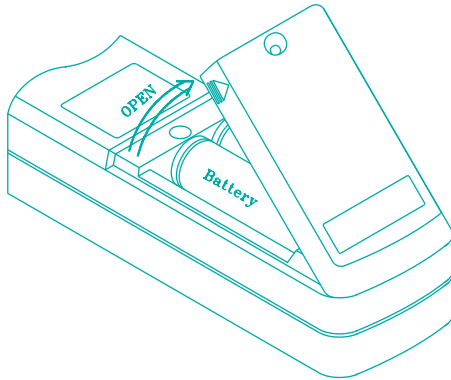

When the low battery symbol is displayed on the LCD, replace the old batteries with two new batteries.

- 5.1. Turn the power off and remove the test leads from the clamp meter.
- 5.2. Remove the screw of the battery compartment.
- 5.3. Lift and remove the battery compartment.
- 5.4. Remove the old batteries.
- 5.5. Insert two new 1.5V SUM-3 batteries.
- 5.6. Replace the battery compartment and secure the screw.

## 6. Maintenance & Cleaning

Servicing not covered in this manual should only be performed by qualified personnel. Repairs should only be performed by qualified personnel.

Periodically wipe the case with a damp cloth and detergent; do not use abrasives or solvents.

Address of Agent, Distributor, Importer, or Manufacturer

--